



SilverKart

étlap

Levesek

Felvezető kör





Magyar Nagydíj



 Gulyásleves / Goulash soup / Gulaschsuppe

790.-

Hazai válogatott



 Húsleves gazdagon / Rich meat soup / Reiche Fleischsuppe

650.-

Zeus nektárja



 Görög gyümölcsleves / Greek fruit soup / Griechische Obstsuppe

790.-

Gumimelegítés



Sajtkrém leves bacon chips-el

/ Cream of cheese soup with bacon crisps

/ Käsecremsuppe mit Bacon-Chips

890.-



A Magyar Champion



Magyaros gombaleves

/ Mushroom soup Hungarian style

/ Pilzsuppe auf ungarische Art

650.-



Francia Nagydíj



Francia hagyma leves

/ French onion soup

/ Französische Zwiebelsuppe

950.-





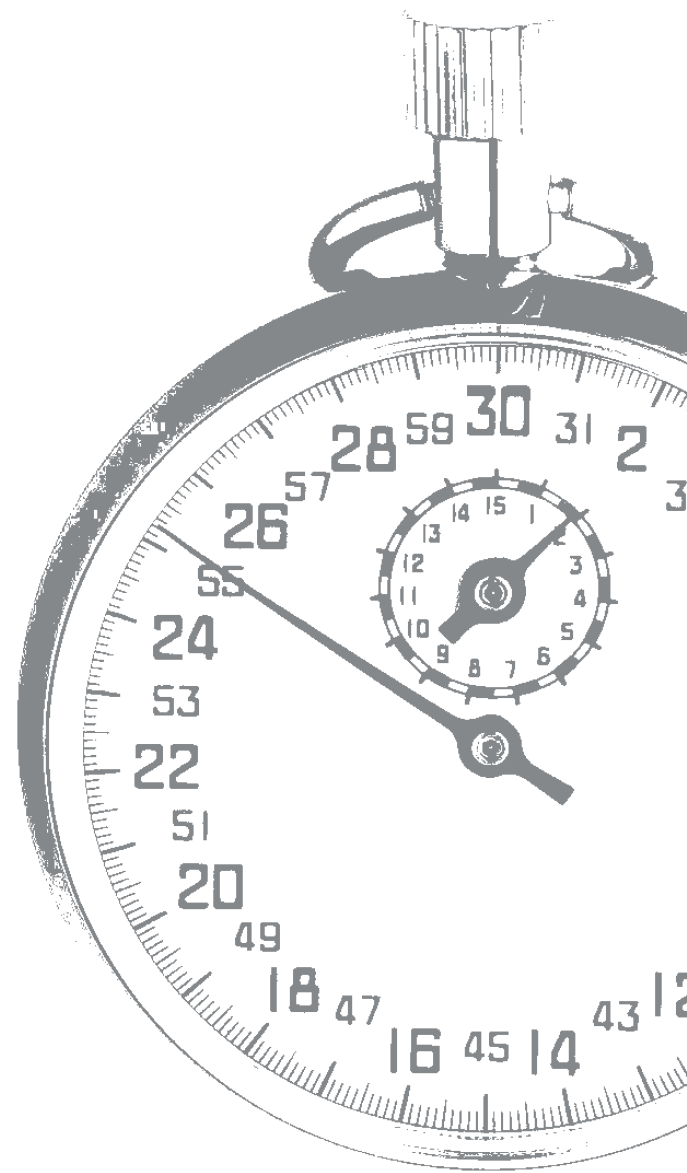

Időmérő Előételek



Kerék csere



 Füstli saláta (friss zöldségek, füstölt tarja, füstölt sajt)

/ Smoky salad (fresh vegetables, smoked spare-ribs, smoked cheese)

/ Räuchersalat (frisches Gemüse, geräucherter Kamm, geräucherter Käse)

1.250.-



 Kertész saláta (friss zöldségek, csirkemell sonka, kukorica joghurtos öntettel)

/ Garden salad (fresh vegetables, chicken breast fillet and corn with yoghurt dressing)

/ Gärtnersalat (frisches Gemüse, Hühnerbrust-Schinken, Mais mit Jogurt-Dressing)

1.150.-

Leggyorsabb kör

 Rántott camambert kék áfonyával, hasáburgonyával

/ Fried Camembert cheese with blueberries and French fries

/ Panierter Camembert mit Blaubeeren und Pommes frites

1.350.-



Box utca

 Mézes-chilis csirkemell saláta ágyon

/ Chicken breast with honey and chili pepper on a bed of lettuce

/ Hühnerbrust in Honig-Chili auf Salatbett

1.350.-





Szabadedzés

Saláták

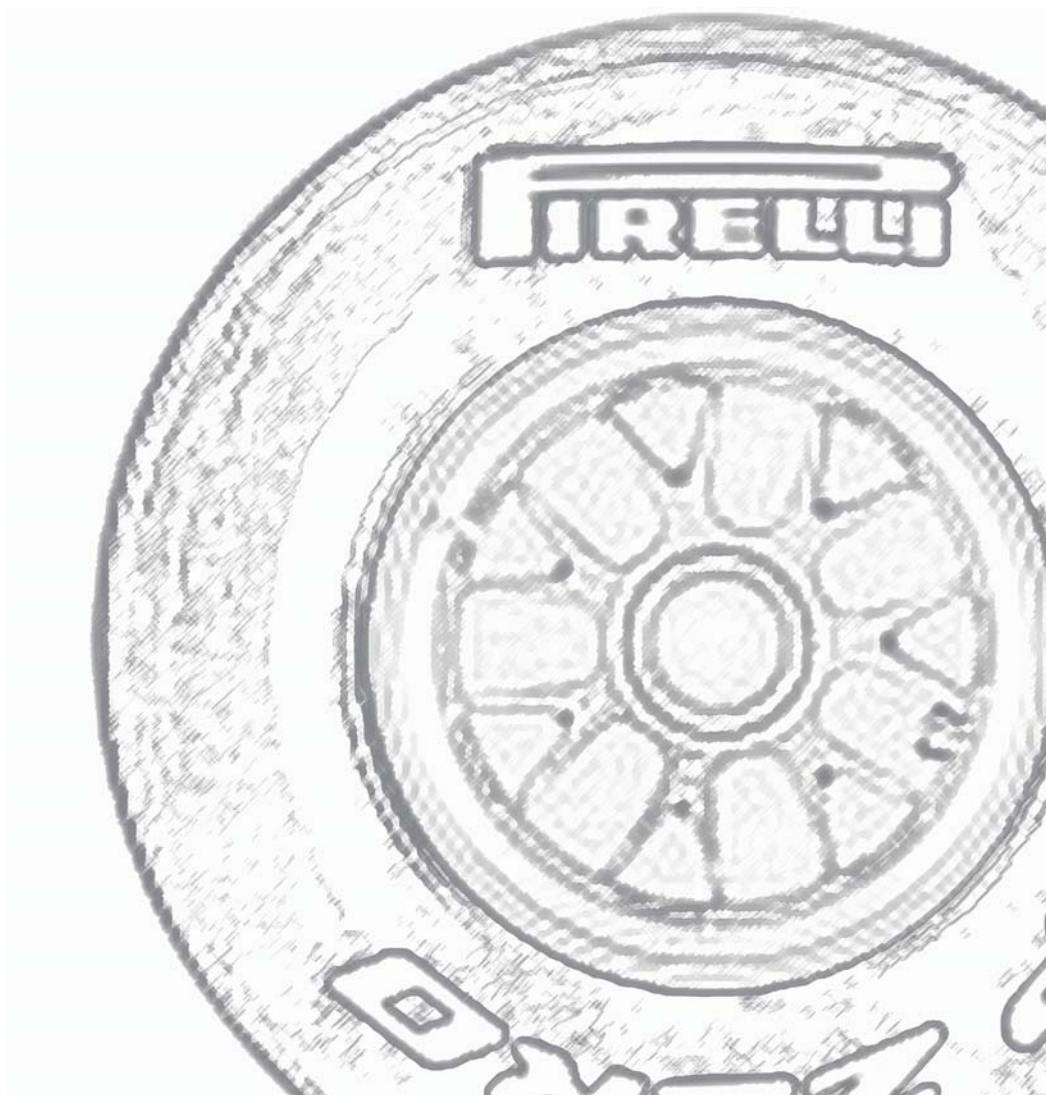





Chicken kör

Cézár saláta (csirkés)

Caesar salad (with chicken)

Cäsarsalat/Ceasar Salad (mit Hühnerfleisch)

1.350.-



Legjobb kanyar

Fittnes saláta

Fitness salad

Fitness-Salat

1.150.-



Göröngyös aszfalt

Görög saláta

Greek salad

Griechischer Salat

1.150.-



Olajfolt

 Paradicsomsaláta

/ Tomato salad

/ Tomatensalat

690.-



Gázfröccs

 Tejfölös uborkasaláta

/ Creamy cucumber salad

/ Gurkensalat mit saurer Sahne

690.-



Esős szakasz

 Vegyes házi savanyúság

/ Mixed pickles of the house

/ Hausgemachter gemischter saurer Salat

550.-



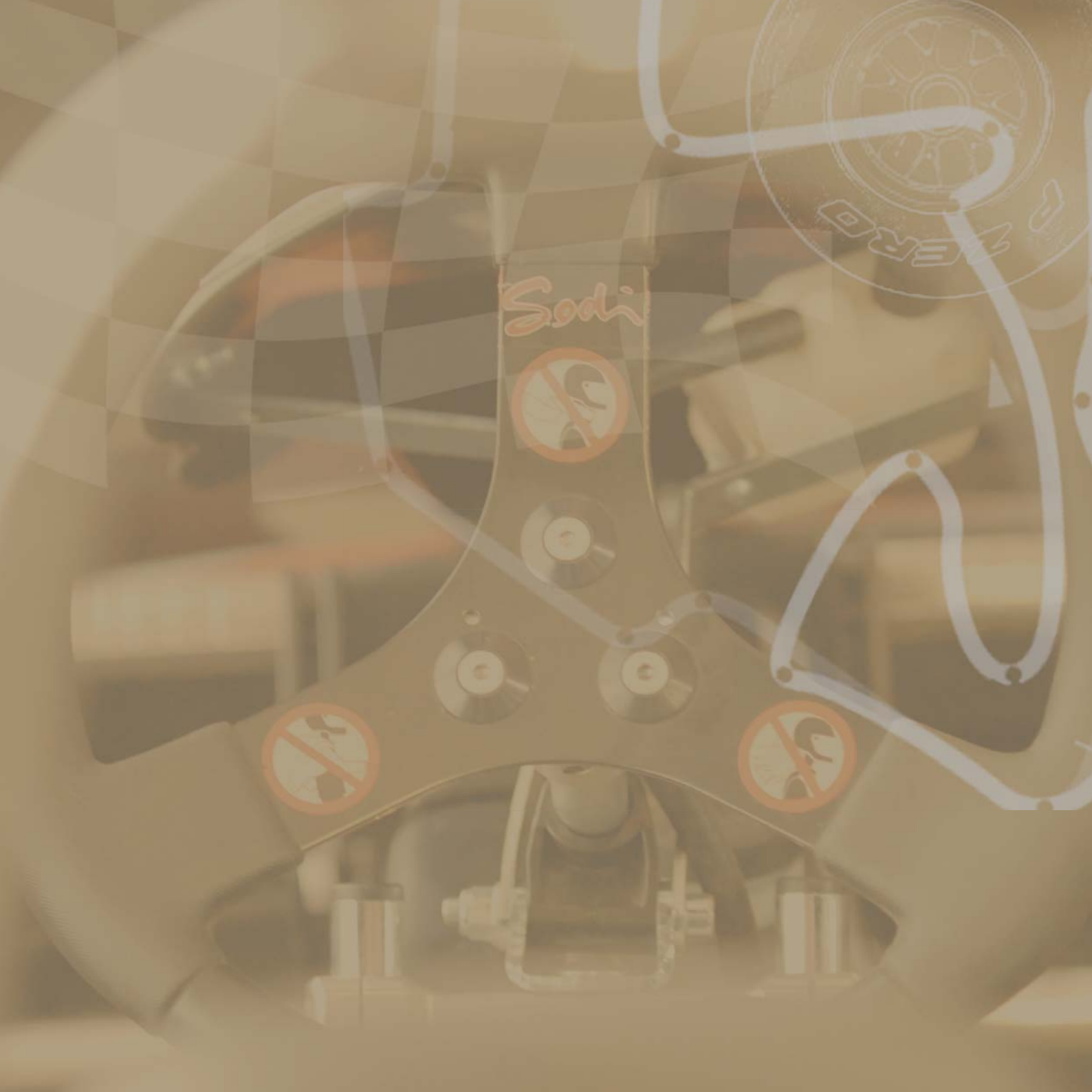

Sodi



MERO

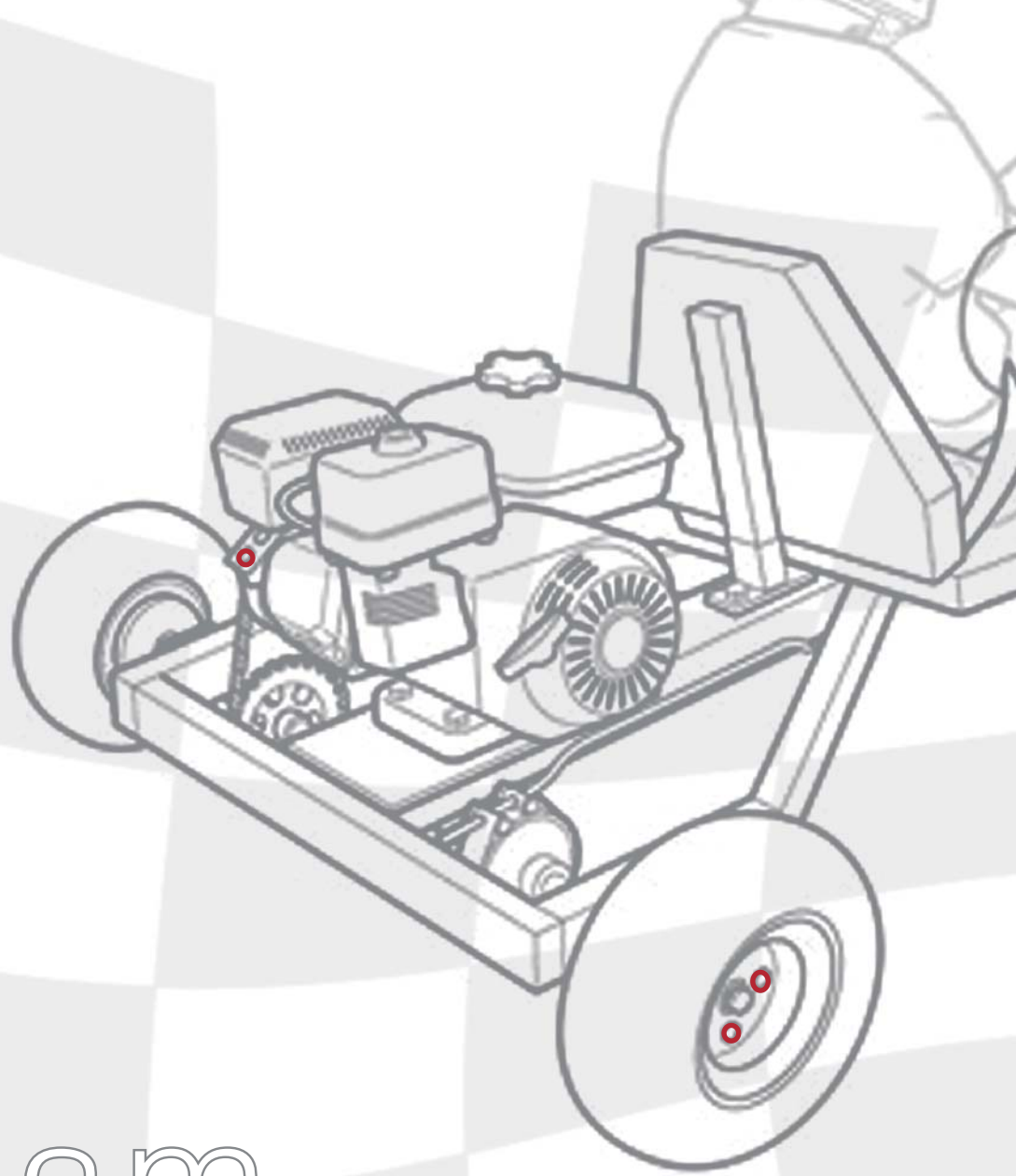

Futam

Főételek



Padlógáz



Sajtbundában sült csirkemell jázmin rizzsel
Roast chicken breast coated with cheese
and garnished with jasmine rice
Hühnerbrust im Käsemantel mit Jasminreis
1.290.-



Safety car



Mozarellával, paradicsommal sült
csirkemell steak burgonyával
Roast chicken breast with tomato and
mozzarella cheese garnished with steak potatoes
Gebratene Hühnerbrust unter Mozzarella und
Tomaten mit Steakkartoffeln
1.590.-



Ideális ív



Cordon Bleu pulykamellből hasáburgonyával
Turkey Cordon Bleu garnished with French fries
Putenbrust-Cordon Bleu (mit Käse und Schinken
gefülltes, paniertes Putenbrustschnitzel)
1.490.-



Legjobb tapadás



Mandulás csirkemell majonézes burgonyasalátával
Chicken breast with almond garnished with potato
salad
Hühnerbrust mit Mandelblättchen
1.450.-



Célvonal

Szűzermék erdei gombamártással,
steak burgonyával, jázmin rizzsel
Medallions of pork with forest mushroom
sauce garnished with brown rice
Jungferbraten-Medallions mit
Waldpilzsoße und Naturreis
1.690.-

Célfotó

Szűzermék baconos zöldbors mártásban
steak burgonyával, jázmin rizzsel
Medallions of pork with bacon and
green peppercorn sauce
Jungferbraten-Medallions in Bacon
mit Grünpeffersoße
1.690.-

Füstölgő gumik

Füstölt tarjával, füstölt sajttal töltött sertéskaraj
fűszeres steak burgonyával
Pork loin filled with smoked spare-ribs and smoked
cheese garnished with spicy steak potatoes
Schweinekotelett mit geräuchertem Kamm und
geräuchertem Käse gefüllt, mit würzigen
Steakkartoffeln
1.650.-

Célegyenes

Lepényhal filé Kárpáti módra petrezselymes
burgonyával
Flatfish Kárpát style
Plattfischfilet auf Karpati-Art
1.950.-





Alkatrészek

Köreték

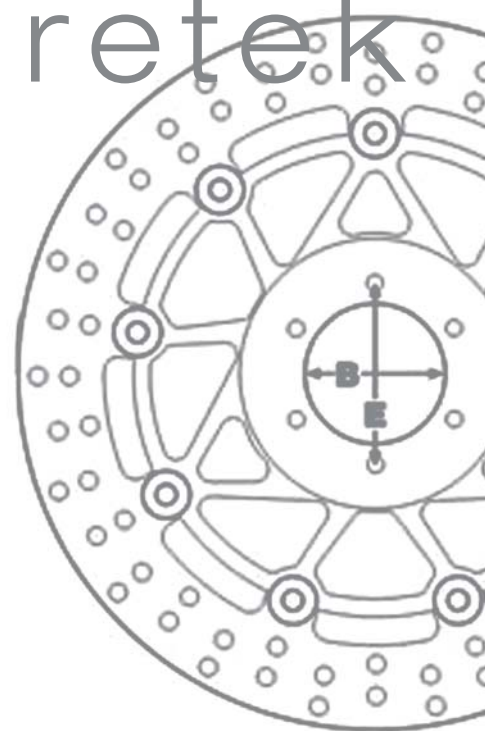





jázmin rizs 450.-

majonézes burgonyasaláta 550.-

kukoricás rizs 490.-

hasábburgonya 690.-

majonézes kukorica saláta 550.-

fűszeres steak burgonya 550.-

rizi-bizi 490.-

petrezselymes burgonya 450.-



Jasmine rice 450.-

Potato salad with mayonnaise 550.-

Rice with corn 490.-

French fries 690.-

Corn salad with mayonnaise 690.-

Spicy steak potatoes 550.-

Rice with green peas 550.-

Potatoes with parsley 450.-



Jasminreis 450.-

Kartoffelsalat mit Mayonnaise 550.-

Reis mit Mais 490.-

Pommes frites 690.-

Maissalat mit Mayonnaise 550.-

Würzige Steakkartoffeln 550.-

Risi-Bisi (Reis mit grünen Erbsen) 490.-

Petersilienkartoffeln 450.-

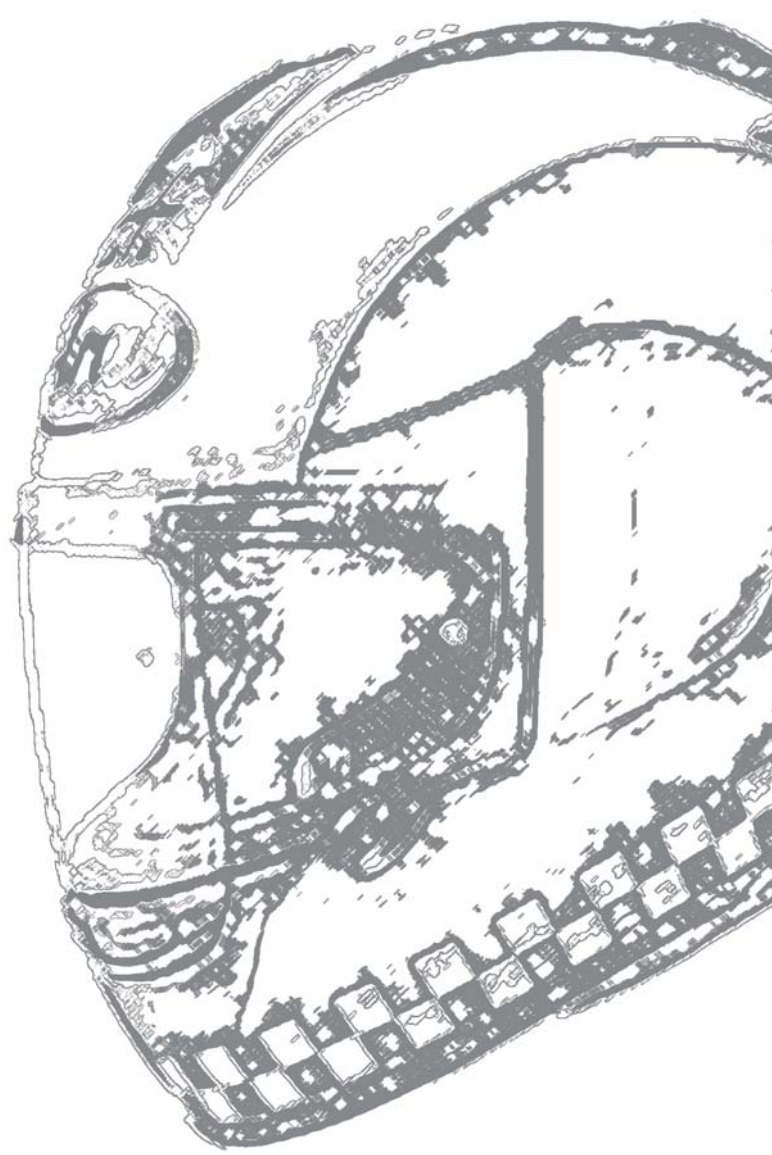

Desszertek Levezető kör



Kockás zászló



Somlói galuska rétes kosárban

Sponge cake Somló style

Schomlauer Nockerln

890.-



A Kupa



Gyümölcs kehely

Fruit cup

Obstbecher

750.-



Díjkiosztó



Gesztenyepüré

Chestnut puré with whipped cream

Maronenpüree

790.-



Végső élvezet



Csokis brownie erdei gyümölcsökkel

Chocolate brownie with forest fruits

Schokoladen-Brownie mit Waldbeeren

850.-



Kék zászló



Palacsinta

(nutellás, kakaós, túrós, ízes, erdei gyümölcsös)

Pancake (with nutella, cocoa powder, cottage-cheese, jam or forest fruits)

Pfannkuchen/Palatschinken (mit Nutella, Kakao,

Quark, Marmelade, Waldbeeren gefüllt)

690.-



Utolsó kör



Somlóival töltött palacsinta csoki öntettel

Pancake filled with sponge cake Somló style, poured with chocolate sauce

Pfannkuchen/Palatschinken mit Schomlaer

Nockerln gefüllt, unter Schokoladensöße

890.-







Pizzák
Nagydíjak



Kínai Nagydíj



Songoku

(paradicsomszós, sajt, sonka, gomba, kukorica)
(tomato sauce, cheese, ham, mushroom, corn)
(Tomatensoße, Käse, Schinken, Pilze, Mais)

28 cm

32 cm

1.150.- 1.390.-



Monzai Nagydíj



Margaréta

(paradicsomszós, sajt, bazsalikom, paradicsom, mozzarella)
(tomato sauce, cheese, basil, tomato, mozzarella cheese)
(Tomatensoße, Käse, Basilikum, Tomaten, Mozzarella)

28 cm

32 cm

1.150.- 1.390.-

Európa Nagydíj



Prosciutto

(paradicsomszós, sajt, sonka)
(tomato sauce, cheese, ham)
(Tomatensoße, Käse, Schinken)

28 cm

32 cm

1.150.- 1.390.-

Német Nagydíj



Hannibal

(paradicsomszós, sajt, bacon, sonka, füstölt tarja, szalámi)
(tomato sauce, cheese, bacon, ham, smoked spare-rib, salami)
(Tomatensoße, Käse, Bacon, Schinken, geräucherter Kamm, Salami)

28 cm

32 cm

1.150.- 1.390.-

Brazil Nagydíj



Hawaii

(paradicsomszós, sajt, sonka, ananász)
(tomato sauce, cheese, ham, pineapple)
(Tomatensoße, Käse, Schinken, Ananas)

28 cm 32 cm
1.150.- 1.390.-



SiLverKart Nagydíj



(tejföl, sajt, póréhagyma, csirkemell, oliva bogyó, feta sajt)
(sour cream, cheese, leek, chicken breast, olives, feta cheese)
(Rahm, Käse, Porree, Hühnerbrust, Oliven, Fetakäse)

28 cm 32 cm
1.150.- 1.390.-

Magyar Nagydíj



Magyaros

(paradicsomszós, sajt, bacon, kolbász, zöldpaprika, hagyma, paradicsom)
(tomato sauce, cheese, bacon, sausages, green pepper, onion, tomato)
(Tomatensoße, Käse, Bacon, Wurst, grüner Paprika, Zwiebeln, Tomaten)

28 cm 32 cm
1.150.- 1.390.-

Kívánság Nagydíj: 4 féle választható feltéttel



Magyaros

(gomba, sonka, bacon, füstölt tarja, csirkemell, szalámi, kukorica, hagyma, zöldpaprika, paradicsom, chili, tejföl, sajt, füstölt sajt)
(mushroom, ham, bacon, smoked spare-ribs, chicken breast, salami, corn, onion, green pepper, tomato, chili)
(Pilze, Schinken, Bacon, geraucherter Kamm, Hühnerbrust, Salami, Mais, Zwiebeln, grüner Paprika, Tomaten, Chili, Rahm, Käse, geräucherter Käse)

28 cm 32 cm
1.250.- 1.390.-



Itallap

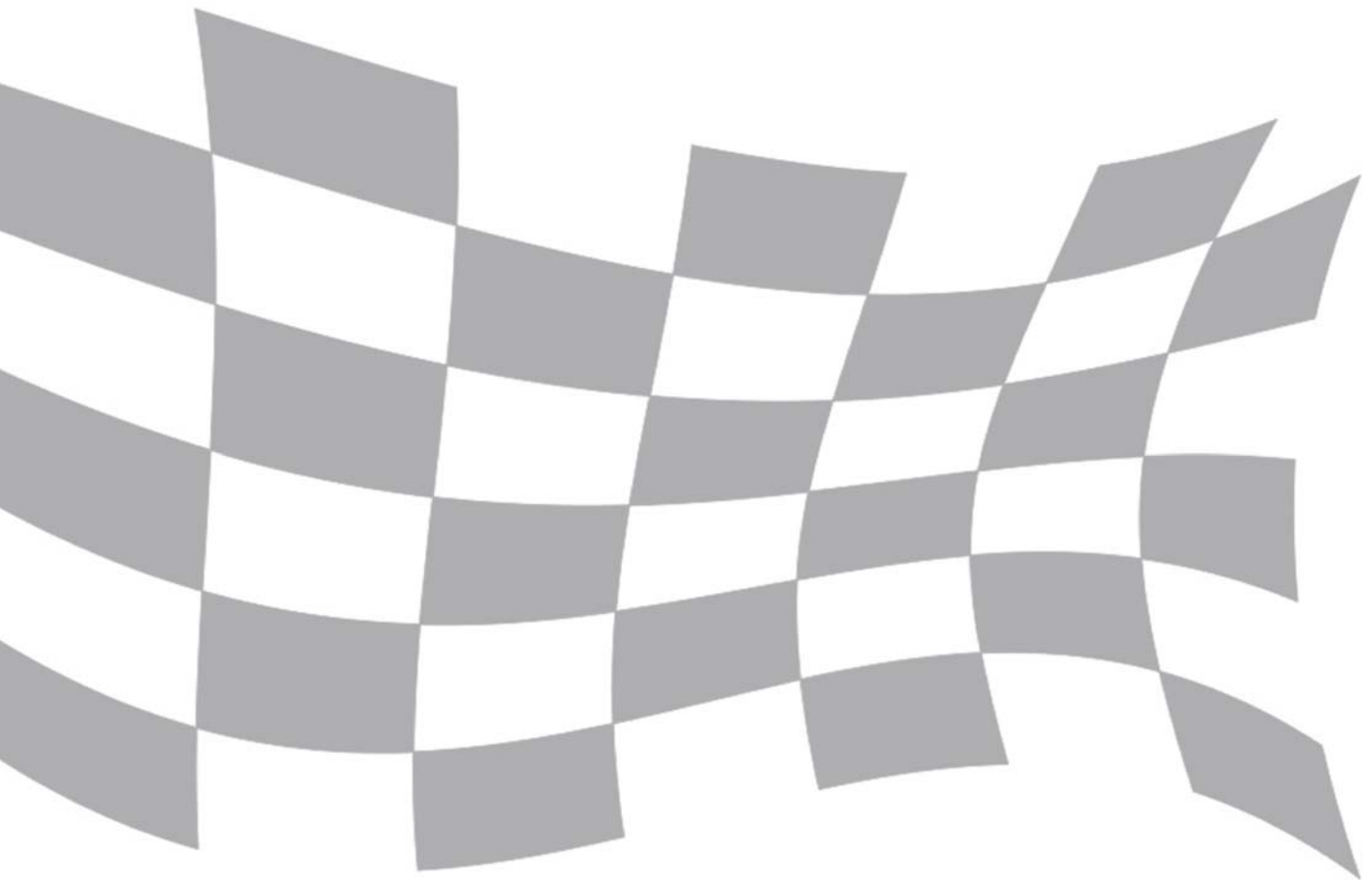



Üdítőitalok / Beverages



Szénsavas üdítők

80.-/ dl

(coca-cola, fanta narancs, tonic, gyömbér, sprite)

Üveges üdítők

240.-/0,2 l

(coca-cola, fanta narancs, fanta citrom,
fanta vadmálna, sprite, gyömbér, tonic)

Rauch rostos üdítők

110.-/ dl

(barack, ananász, meggy, körte,
narancs, alma, sárgadinnye-ananász)

Rauch Ice Tea

90.-/ dl

(barackos, citromos)

Limonádé

350.-/0,3 l

600.-/0,5 l

Naturaqua ásványvíz

240.-/0,33 l

(szénsavas, szénsavmentes)

Forró tea

300.-/0,2 l

(több ízben)

Forró csoki

360.-/0,25 l

Monster (energia ital)

650.-/0,5 l (dobozos)

Pezsgő / Champagne



Törley Charmant (száraz, édes) 2.500.-/0,7 l

Sörök / Beers



Heineken (csapolt) 350.-/0,25 l

600.-/0,5 l

Heineken (üveges) 420.-/0,33 l

Soproni (csapolt) 270.-/0,25 l

450.-/0,5 l

Alkoholmentes Gösser (üveges) 420.-/0,33 l

Citromos Gösser (üveges) 420.-/0,33 l

Coronita 700.-/0,5 l

Edelweis búza sör 700.-/0,5 l



Whisky:

Johnnie Walker Red Label	800.-/4 cl
Jim Beam	800.-/4 cl
Jack Daniels	800.-/4 cl
Ballantines	800.-/4 cl

Keserű:

Jägermeister	800.-/4 cl
Unicum, Unicum Next	800.-/4 cl
Campari	650.-/8 cl

Rum:

Bacardi, Bacardi Black	800.-/4 cl
Spitz	1.200.-/4 cl

Vodka:

Finlandia	800.-/4 cl
-----------	------------

Tequila:

Sierra, Gold	800.-/4 cl
--------------	------------

Konyak:

Napoleon	800.-/4 cl
Metaxa ***	800.-/4 cl
Metaxa *****	1.200.-/4 cl
Hennesy	1.200.-/4 cl



Pálinka:

Zwack Kosherszilva, barack	800.-/4 cl
----------------------------	------------

Párlat:

Fütyülős mézes szilva, barack	800.-/4 cl
Vilmos eredeti, mézes, fűszeres	800.-/4 cl

Vermut:

Martini (édes, száraz)	650.-/8 cl
------------------------	------------

Likőr:

Baileys	800.-/4 cl
---------	------------

Egyéb rövid italok:

Ouzo, Malibu, Gin	800.-/4 cl
Bacardi Breezer	750.-/0,275 l
(citrom, lime, narancs, dinnye)	

Szakácsaink:

Csuha Róbert
Reichert Tamás



SiLverKart Budapest
1108 Budapest Kozma utca 3.
gokart@silverkart.hu
www.silverkart.hu